



ProMariner®

MARINE

RV

INDUSTRIAL

NAVICO GROUP

TAKING YOU FURTHER

Navico Group is the world's leading supplier of integrated systems and products to industries ranging from marine to recreational vehicle and beyond. We offer an unmatched portfolio comprised of industry-leading brands in power management, digital control & monitoring, networked devices and marine electronics.

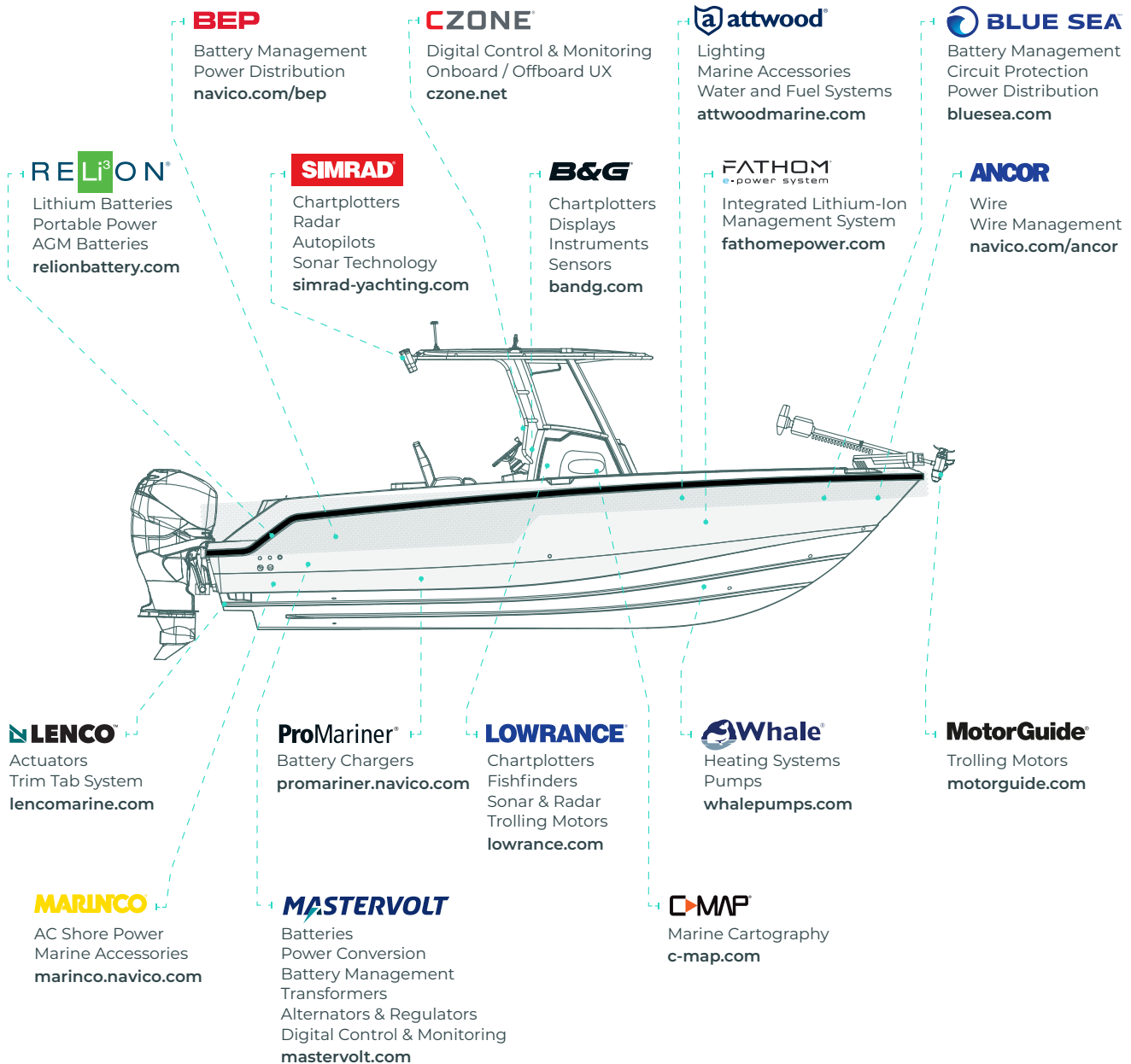

See how far our innovations can take you at Navico.com

Ingress Protection (IP) Ratings Guide





Example:





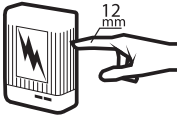

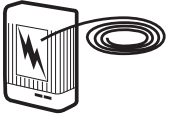

An IP65 rating can be determined using the adjacent table and example:

- The first number of the rating example, 6, in the gray column means the enclosure is dust tight
- The second number of the rating example, 5, in the blue column means the enclosure is protected against jets of water

The IP rating system was established by the International Electrotechnical Commission (IEC), an organization for international standards and conformity assessment. The IEC collaborates closely with the International Organization for Standardization (ISO). A complete description of the IP ratings and associated tests is found in IEC Publication 529. Although these ratings were initially developed as a way to classify enclosures, they now provide a convenient, practical way to compare levels of sealing. Many electrical products have an Ingress Protection (IP) rating which identifies the environmental factors needing consideration prior to the product's installation.

This is important when deciding when to mount products in a dry and clean environment versus a wet and/or dusty environment. The IP rating indicates the degree of protection provided. The numbers following IP represent levels of sealing and can range from no protection to full protection against dust and water. The table provides a description of the protection at each level.

SOLIDS	
1	 <p>Protected against a solid object greater than 50 mm such as a hand.</p>
2	 <p>Protected against a solid object greater than 12 mm such as a finger.</p>
3	 <p>Protected against a solid object greater than 2.5 mm such as a screwdriver.</p>
4	 <p>Protected against a solid object greater than 1 mm such as a wire.</p>
5	 <p>Dust Protected, Limited ingress of dust permitted. Will not interfere with operation of the equipment. Two to eight hours.</p>
6	 <p>Dust tight. No Ingress of dust. Two to eight hours.</p>

WATER	
1	 <p>Protected against vertically falling drops of water. Limited ingress permitted.</p>
2	 <p>Protected against vertically falling drops of water with enclosure tilted up to 15 degrees from the vertical. Limited ingress permitted.</p>
3	 <p>Protected against sprays of water up to 60 degrees from the vertical. Limited ingress permitted for three minutes.</p>
4	 <p>Protected against water splashed from all directions. Limited ingress permitted.</p>
5	 <p>Protected against jets of water. Limited ingress permitted.</p>
6	 <p>Water from heavy seas or water projected in powerful jets shall not enter the enclosure in harmful quantities.</p>
7	 <p>Protection against the effects of immersion in water between 15 cm and 1 m for 30 minutes.</p>
8	 <p>Protection against the effects of immersion in water under pressure for long periods.</p>

Rating Example:

IP65

INGRESS PROTECTION



What makes ProMariner different:

I Founder's Vision

ProMariner was founded in 1978 with one premise: to make boating more enjoyable. We pioneered a robust line of fully automatic, on-board marine battery chargers that provided the marine industry with a mainstream method of charging batteries in a short time without the need for storing or carrying portable battery chargers on-board. We haven't looked back since.

Today, ProMariner is the industry leader in marine and mobile battery charging. We have a complete line of waterproof and dry-mount chargers for all battery chemistries, as well as technically advanced power conversion modules. All our products are designed to prolong the life of your batteries and keep you on the water longer.

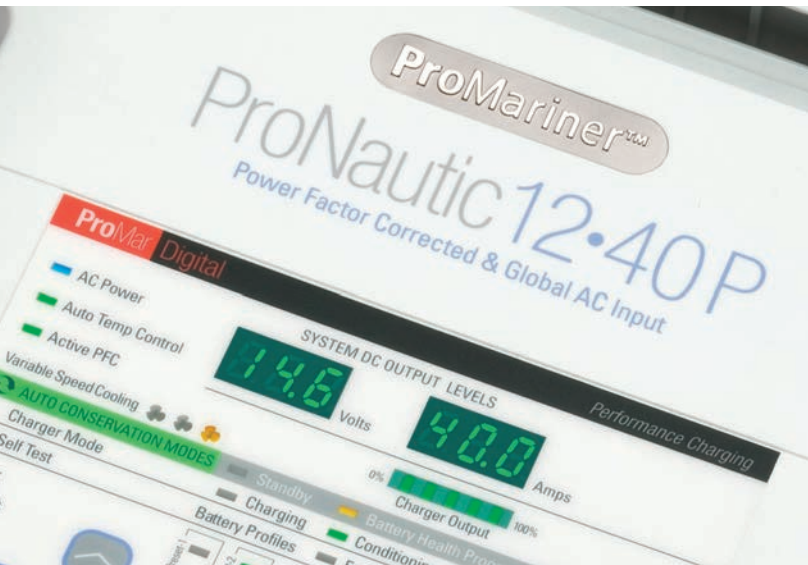

I Innovation & Engineering

ProMariner designs and engineers a complete range of high performance, state-of-the-art marine battery chargers and accessories. Exclusive technologies, such as Distributed on Demand™ ensure that ProMariner chargers will deliver the fastest charge and protect your battery investment.



I Selection

With the broadest range of on-board charging products in the industry, ProMariner offers performance based solutions for all boats. Whether it is a waterproof charger for your fishing boat, or a vented charger for your larger boat, ProMariner has a charger to fit your needs.

I Worldwide Access to Product

A global distribution network provides easy access to products where they are needed.

I Industry Standards

Industry involvement ensures products meet UL1236, ABYC, NMMA, CEC, DOE and USCG standards.

I Quality

Product quality is extremely important at ProMariner. We manage product quality in a manner consistent with international standards to ensure all ProMariner products exceed expectations.

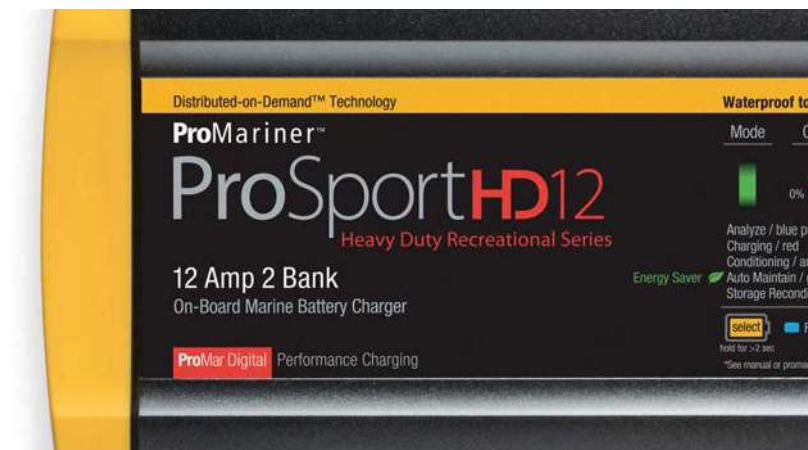

NEW Products

10 and 12

ProTournamentelite series³

NEW! ProTournamentelite series³ provides a competitive edge getting you on the water first with power to last. Delivering true-rated constant current charging amperage for the fastest charge times. Full output 5-stage digital performance charging, maximizing battery life and performance. 100% charging performance with AC voltage as low as 90 VAC. User selectable charging profiles for Flooded, AGM and ProMariner approved LiFePO4** chemistries.

All ProTournamentelite models, boast an industry-first LED Charge Status AC Glow Plug*, that illuminates 3 individual colors for charging, conditioning or auto maintaining your fully charged batteries.

USA			Global		
Part # 53242	24A	2 Bank	Part # 55363	36A	3 Bank
Part # 53243	24A	3 Bank	Part # 55364	36A	4 Bank
Part # 53244	24A	4 Bank	Part # 55505	50A	5 Bank
Part # 53363	36A	3 Bank			
Part # 53364	36A	4 Bank			
Part # 53505	50A	5 Bank			

CZone Integrated NMEA 2000 Communication Port



Charge Status AC Glow Plug*

Color may vary



14 and 16

ProSportHD Series Lithium—USA & Global

The new ProSportHD features a lightweight, tri-surface heatsink design. This delivers significantly faster charging through optimal cooling, while delivering true rated constant current charging amps during charge mode. Fully automatic multi-stage charging enhances battery performance while extending battery life. User selectable charging profiles for Flooded, AGM, Gel and ProMariner approved LiFePO4** chemistries.

USA		Global	
Part # 44006	6A	Part # 44023	6A
Part # 44008	8A	Part # 44026	12A
Part # 44012	12A	Part # 44028	20A
Part # 44020	20A	Part # 44029	20A (plus)
Part # 44021	20A (plus)		



37

Battery Isolators

ProMariner Battery Isolators with gold-plated terminals and improved efficiency, provide enhanced charging. Rated for use with DC devices ranging from 10 amps to 70 amps.

Part # 11072	70A	Part # 11132	130A
Part # 11073	70A	Part # 11133	130A
Part # 12072	70A	Part # 12132	130A
Part # 12073	20A	Part # 12133	130A





*Patent pending

**See manual or promariner.com/Li for approved LiFePO4 batteries and warnings

Table of Contents

Waterproof Battery Chargers

Waterproof Battery Chargers Selection	8	NEW		p. 10
ProTournament <i>elite</i>	10			
ProTournament <i>elite</i> —Global	12			
ProSportHD	14			
ProSportHD—Global	16			
ProMar1 Digital Series	18	NEW		p. 14
1.5 Amp Battery Maintainer	20			





Vented Battery Chargers

ProNauticP Series	24		p. 24
-------------------	----	---	-------

Commercial/Industrial Chargers

ProTechOne Battery Chargers	28		p. 28
-----------------------------	----	---	-------



Inverters

TruePower Plus Series	32		p. 32
ProSport Power Inverters	33		p. 33

Isolators and Combiners

ProIsoCharge Series	36		p. 36
Multi Battery Isolator	37		
ProSafeFS Series	38		
Multi Battery Combiner	39		p. 37
			p. 38
			p. 39

Accessories

Plug Holders	42		p. 42
Cable Extenders	43		
Remote Battery Bank Status Indicator	44		
Testers	44		p. 43
			p. 44

Appendix & Index

Part Number Index	46
-------------------	----

WATERPROOF BATTERY CHARGERS

ProTournamentelite series³



ProTournamentelite series³ provides a competitive edge getting you on the water first with power to last. Delivering true-rated constant current charging amperage for the fastest charge times. Full output 5-stage digital performance charging, maximizing battery life and performance. 100% charging performance with AC voltage as low as 90 VAC and automatic charging profiles including approved LiFePO4.

ProSportHD Series



ProSportHD On-Board Marine Battery Chargers incorporate all-digital microprocessor control. Like no other, the ProSportHD Series provides automatic installation feedback with its "System Check OK" and individual dual mode "Battery Status" LED indicators and automatic charging profiles including approved LiFePO4.



WATERPROOF BATTERY CHARGERS

ProMar1 Digital Series



18

ProMar1 DS incorporates solid state and fully automatic technology that eliminates the need to use portable battery chargers for charging each battery on-board one at a time. Our compact design is lightweight and pre-wired for quick and easy installation.

1.5 Amp Battery Maintainer



20

ProSport 1.5 amp fully automatic maintainer is an innovative multi-use charger designed for maximum utility. Concealed mounting holes allow the ProSport 1.5 to be installed on-board or to be used as a portable, with rear die cut foam resting pad. Ring terminal and DC clamp quick connect cable assemblies included.



Waterproof Battery Chargers

ProTournamentelite series³

Fastest Charge Times

Fastest Charge Time

- Distributed-On-Demand ensures the max amps being delivered
- Max amps per bank—4 to 8 hr charge time
- Charges Flooded, AGM, HP AGM, and approved LiFePO4 batteries

Most Precise Charging

- Selectable battery types for optimized charge profiles

System Feedback

- Integrated LEDs tell you charge status at all times

Global models

- CZone Integrated NMEA 2000 Communication Port

Charge Status AC Glow Plug*

Color may vary



*Patent pending

FASTEST
4 to 8 HR
CHARGE TIME

NEW



For Approved*
LiFePO₄
Lithium-ion
Batteries

ProSportHD Series

Increased Power and Performance

Faster Charge Time

- Distributed-On-Demand ensures the max amps being delivered
- Max amps per bank—8 to 10 hr charge time
- Charges Flooded, Gel, AGM, HP AGM^o, and LiFePO4 batteries

Most Precise Charging

- Selectable battery types for optimized charge profiles

System Feedback

- Integrated LEDs tell you charge status at all times

^oHP AGM profile only available in the ProSportHD 20 Dual.

FASTER
8 to 10 HR
CHARGE TIME

NEW



For Approved*
LiFePO₄
Lithium-ion
Batteries

ProMar1 Digital Series

Industry Standard Power Ratings

Fast Charge Time

- Fully automatic 4-stage charging with Auto-maintain/Energy saver mode
- Max amps per bank—10 to 12 hr charge time
- Charges Flooded and Gel batteries

System Feedback

- Integrated LEDs tell you charge status at all times

FAST
10 to 12 HR
CHARGE TIME



How Distributed-On-Demand™ Technology Works

(ProTournamentelite and ProSportHD Models)

Distributed-On-Demand™ Charging Technology ensures 100% of the available charging amperage is fully utilized to meet the demand of each battery on-board. For example, if your engine start battery only needs 2A from your ProSportHD 12 (6/6 two bank charger), the unused 4A will be automatically Distributed-On-Demand™ to your house or trolling motor battery, providing a total of 10A for faster charging versus only 5A that the conventional 5/5 battery charger would provide. The competitive 5/5 charger has a 5A limit per bank.

This illustration reflects typical battery usage after a day of fishing. Trolling motor batteries are 50% discharged and not usable. Engine start battery is 90% charged from the engine charging system.

Note: ProTournamentelite regulates a max distribution of 18 Amps to any one battery.

DISTRIBUTED ON DEMAND™ TECHNOLOGY

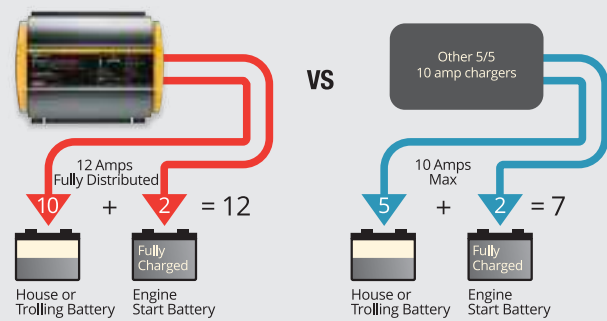

System Check Info

(ProTournamentelite and ProSportHD Models)

System OK Status Indicators

After applying AC power, the charger will self test and analyze the battery connections and batteries.

Battery Bank Trouble Status Indicators

Advanced technology eliminates time consuming troubleshooting by clearly indicating system and battery connections are OK or if a fault is present on a specific battery bank.

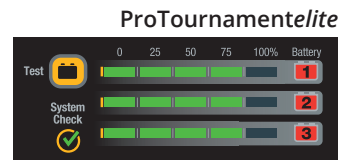

Selectable Performance

ProTournamentelite and ProSportHD Lithium provide different charge profiles to match multiple battery chemistries.

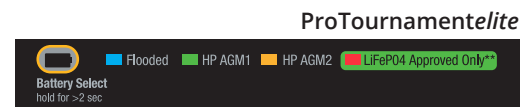

ProTournamentelite series³ NEW
Getting you on the water first with power to last

Taken to a new level of design, innovation, and performance, ProMariner's ProTournamentelite series³ provides a competitive battery charging edge designed to get boaters out on the water first with power to last.

Incorporating three patent-pending features not yet seen in the industry, ProMariner ProTournamentelite series³ battery chargers include a Charge Status AC Glow Plug, Power Flow Cooling and Turbo Charge capabilities for the fastest and most intuitive performance on-board marine charger available, including a new market-leading five bank, 50 Amp charger.

A professional grade charger like no other

TurboCharge Technology & Power Flow Cooling*

Available on 360 and 500 models

Fastest Charge Times with Distributed-On-Demand™ Technology

Full Output 5-Stage Digital Performance Charging

Fully automatic multi-stage charging: analyzing, charging, conditioning, auto maintain (energy saver mode) and once a month storage recondition mode.

Digital LED Display with Dual Function Battery Status Monitor

Individual battery charge level monitor with an on-the-water push-to-test feature for percent of battery power remaining. Eliminate time consuming trouble shooting by indicating system OK or specific batteries requiring attention.

Auto Maintain / Energy Saver Mode

4 Selectable Charge Profiles with Temperature Compensation
 Standard and High Performance (HP) charge profiles: Flooded/Absorbed Glass Mat (AGM) batteries, HP AGM 1 for pure lead AGM's, HP AGM 2 for pure lead AGM's, or LiFePO4** for approved LiFePO4 batteries. Only charge ProMariner approved LiFePO4 batteries.

Tri-Surface Heat Sink Design

New! 50 Amp 5 Bank and 24 Amp 4 Bank Models Available

IP67 Rated waterproof



53243



53363



Tri-Surface Heat Sink Design



Waterproof Connector Port for Optional Remote



Optional Remote 53600

*Patent pending

**See manual or promariner.com/Li for approved LiFePO4 batteries and warnings

Conforms to UL STD. 1236
 Certified to CSA STD. C22.2 No. 107.2
 FCC Class B, CEC and DOE Listed
 Designed and constructed to ABYC A-31



Approved Lithium

Charge Status AC Glow Plug*

Color may vary



Charging Conditioning Auto Maintain

ProTournamentelite series³ Selection



Model	ProTournamentelite 240 Two Bank	ProTournamentelite 240 Three Bank	ProTournamentelite 240 Four Bank	ProTournamentelite 360 Three Bank	ProTournamentelite 360 Four Bank	ProTournamentelite 500 Five Bank
Part #	53242	53243	53244	53363	53364	53505
Voltage	12/24	12/24/36	12/24/36/48	12/24/36	12/24/36/48	12/24/36/48 + Eng
Amps	24A	24A	24A	36A	36A	50A
Banks	2 Banks	3 Banks	4 Banks	3 Banks	4 Banks	5 Banks
Power Flow Cooling	—	—	—	yes	yes	yes
Turbo Charge Selectable	—	—	—	yes	yes	yes
AC & DC Cables	6'	6'	6'	6'	6'	6'
Size	7.1"x3.2"x13.4"	7.1"x3.2"x13.4"	7.1"x3.2"x13.4"	9.3"x4.2"x13.7"	9.3"x4.2"x13.7"	9.3"x4.2"x13.7"
Weight	9 lbs	9.5 lbs	9.9 lbs	15.4 lbs	15.8 lbs	16.9 lbs
VAC / Max Amps	120 +/- 10% VAC / 7.5A	120 +/- 10% VAC / 7.5A	120 +/- 10% VAC / 7.5A	120 +/- 10% VAC / 10A	120 +/- 10% VAC / 10A	120 +/- 10% VAC / 13A
AC Plug	NEMA 5-15	NEMA 5-15	NEMA 5-15	NEMA 5-15	NEMA 5-15	NEMA 5-15

Note: For use with Group 24 through 31 Flooded (lead-acid), AGM and LiFeO4** approved batteries. Check promariner.com/Li for full list of approved Lithium models. Not for use 4D or 8D large capacity batteries. For these applications, see ProMariner's ProNauticP Series on page 24.

5 Stage Performance Charging Overview

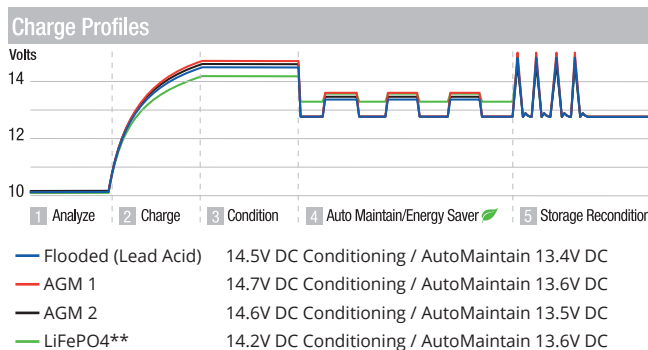

**Only charge approved LiFePO4 batteries. See manual or promariner.com/Li for approved LiFePO4 batteries and warnings

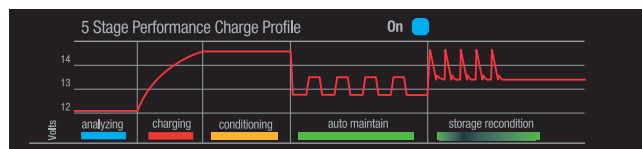

Full Output 5-Stage Performance Charging

Fully automatic multi-stage charging: analyzing, charging, conditioning, auto maintain (energy saver mode) and once a month storage recondition mode.

Factory Set for Flooded/Lead-Acid Batteries

Stage 1 - Analyze & System Check OK

During this stage the ProTournamentelite Analyze LED will pulse blue indicating it is analyzing all battery connections and ensuring each battery is capable of being charged. When completed successfully, the "System Check OK" indicator will illuminate green. This takes approximately 1 minute.

Stage 2 - Charge

During this stage the ProTournamentelite Charge LED will be solid red and will use all of its available charging amps (as controlled by temperature) until the battery voltage is raised to the selected absorption voltage.

Stage 3 - Condition

During this stage the ProTournamentelite Conditioning LED will be solid amber. During this mode batteries will be held at the selected absorption voltage to complete charging while conditioning each battery connected for up to 3 hours as needed.

Stage 4 - Auto Maintain (Energy Saver Mode)

During this stage the Auto Maintain LED will be solid green, indicating it is monitoring and auto maintaining your batteries as needed to maintain a full state of charge. At this time, the blue Power LED, green System OK, green Auto Maintain and green Charge Status LEDs will remain on letting you know your batteries are ready when you are.

Stage 5 - Storage Recondition

During this stage the ProTournamentelite will enter into its once a month Storage Recondition mode, illuminating its green LED. The LED will pulse indicating that while your batteries/boat are in storage, the ProTournamentelite is reconditioning all batteries for up to 3 hours once a month to extend battery life and provide maximum reserve power performance on the water.

NMEA 2000® is a Registered Trademark of the National Marine Electronics Association Inc.

Related Products



AC Plug Holder page 42



Cable Extender page 43

ProTournamentelite series³—Global **NEW** Tournament Winning Global AC Input On-Board Marine Battery Charger

NEW! ProTournamentelite series³ provides a competitive edge getting you on the water first with power to last. Delivering true-rated constant current charging amperage for the fastest charge times. Full output 5-stage digital performance charging, maximizing battery life and performance. 100% charging performance with AC voltage as low as 90 VAC. User selectable charging profiles for Flooded, HP AGM 1, HP AGM 2, and ProMariner approved LiFePO4** chemistries.

All ProTournamentelite models, boast an industry-first LED Charge Status AC Glow Plug*, that illuminates 3 individual colors for charging, conditioning or auto maintaining your fully charged batteries. High Power ProTournamentelite 360 and 500 models feature an industry leading selectable Turbo Charge Mode* with Forced Induction Power Flow Cooling* for time critical charging.

Full output 5-stage digital performance charging to charge, condition, auto maintain and storage recondition your batteries once a month, maximizing battery life and performance. 100% charging performance with AC voltage as low as 90 VAC. System Check OK and Check Battery indicators, Charge Mode LEDs and a dual mode battery status monitor displaying charge progress or on the water power remaining. User selectable charging profiles for Flooded, AGM and ProMariner approved LiFePO4** chemistries.

Designed to last in harsh environments and certified to UL Marine 1236 while meeting new energy efficient CEC and DOE requirements. Built-in safety features including dual inline waterproof fuses, reverse polarity, over-temperature, over-current, over-voltage and ignition protection.

- TurboCharge Technology & Power Flow Cooling*
- Fastest Charge Times with Distributed-On-Demand™ Technology
- Full Output 5-Stage Digital Performance Charging
- Digital LED Display with Dual Function Battery Status Monitor
- Auto Maintain / Energy Saver Mode
- CZone Integrated NMEA2000® Communication Port Provides: Battery Chemistry, Charge Mode, Real-Time Charging Voltage, Amperage and Fault Status
- 5 Year Warranty



Global AC Input

100-240 VAC 50/60 Hz



55505



55363



Tri-Surface Heat Sink Design



CZONE Integrated NMEA2000® Communication Port



Optional Remote
53600

*Patent pending

**See manual or promariner.com/Li for approved LiFePO4 batteries and warnings

Conforms to UL STD. 1236
Certified to CSA STD. C22.2 No. 107.2
FCC Class B, CEC and DOE Listed
Designed and constructed to ABYC A-31



Charge Status IEC Glow Plug*
Color may vary



Charging Conditioning Auto Maintain

ProTournamentelite series³—Global Selection



Model	ProTournament G360 Three Bank	ProTournament G360 Four Bank	ProTournament G500 Five Bank
Part #	55363	55364	55505
Voltage	12/24/36	12/24/36/48	12/24/36/48 + Eng
Amps	36A	36A	50A
Banks	3 Banks	4 Banks	5 Banks
AC & DC Cables	6'	6'	6'
Size	9.3"x4.2"x14.7" 23.6 x 10.7 x 34.8cm	9.3"x4.2"x14.7" 23.6 x 10.7 x 34.8cm	9.3"x4.2"x16.6" 23.6 x 10.7 x 42.2cm
Weight	16.1 lbs	16.8 lbs	18.0 lbs
VAC / Max Amps	100–240 VAC / 8A	100–240 VAC / 8A	100–240 VAC / 10A
AC Plug	IEC C14	IEC C14	IEC C14

Note: For use with Group 24 through 31 Flooded (lead-acid), AGM and LiFeO4** approved batteries. Not for use 4D or 8D large capacity batteries. For these applications, see ProMariner's ProNauticP Series on page 24.

C13 Plug Adapters

For Global Universal IEC C14 power cords. Available in country C13 plug adapters as shown (not included).

Also available in weatherproof locking version (subject to availability).



Universal IEC c14 power cord



US	92100	Weatherproof Locking
Europe	92110	Weatherproof Locking
Austria	92130	Weatherproof Locking
UK	92140	Weatherproof Locking
Brazil	92170	Weatherproof Locking

5 Stage Performance Charging Overview

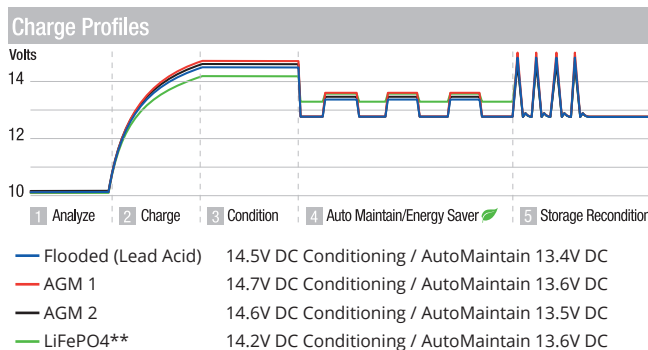

**Only charge approved LiFePO4 batteries. See manual or promariner.com/Li for approved LiFePO4 batteries and warnings

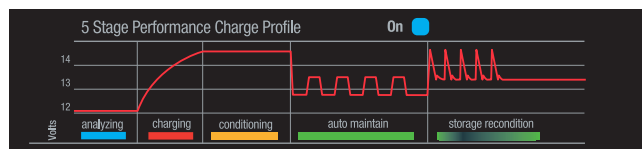

Full Output 5-Stage Performance Charging

Fully automatic multi-stage charging: analyzing, charging, conditioning, auto maintain (energy saver mode) and once a month storage recondition mode.

Factory Set for Flooded/Lead-Acid Batteries

Stage 1 - Analyze & System Check OK

During this stage the ProTournamentelite Analyze LED will pulse blue indicating it is analyzing all battery connections and ensuring each battery is capable of being charged. When completed successfully, the "System Check OK" indicator will illuminate green. This takes approximately 1 minute.

Stage 2 - Charge

During this stage the ProTournamentelite Charge LED will be solid red and will use all of its available charging amps (as controlled by temperature) until the battery voltage is raised to the selected absorption voltage.

Stage 3 - Condition

During this stage the ProTournamentelite Conditioning LED will be solid amber. During this mode batteries will be held at the selected absorption voltage to complete charging while conditioning each battery connected for up to 3 hours as needed.

Stage 4 - Auto Maintain (Energy Saver Mode)

During this stage the Auto Maintain LED will be solid green, indicating it is monitoring and auto maintaining your batteries as needed to maintain a full state of charge. At this time, the blue Power LED, green System OK, green Auto Maintain and green Charge Status LEDs will remain on letting you know your batteries are ready when you are.

Stage 5 - Storage Recondition

During this stage the ProTournamentelite will enter into its once a month Storage Recondition mode, illuminating its green LED. The LED will pulse indicating that while your batteries/boat are in storage, the ProTournamentelite is reconditioning all batteries for up to 3 hours once a month to extend battery life and provide maximum reserve power performance on the water.

OPTIMA BLUETOP® is a trademark of Clarios / ODYSSEY® is a trademark of EnerSys. NMEA 2000® is a Registered Trademark of the National Marine Electronics Association Inc.

*Patent pending

**See manual or promariner.com/Li for approved LiFePO4 batteries and warnings †Trademarks of Brunswick Corp.

Related Products



Cable Extender page 43

ProSportHD Series Lithium **NEW** On-Board Waterproof Battery Charger

ProSportHD series 4 boasts a new aggressive heavy duty tri-surface heatsink design. This lightweight design delivers faster charging through optimal cooling, while delivering true rated constant current charging amps during charge mode. User selectable charging profiles for Flooded, AGM, Gel and ProMariner approved LiFePO4** chemistries.

ProSportHD's enhanced microprocessor and software control sports a dashboard of new digital features including: fuel gauge style Charge Completion Monitor, Charge Mode LED bar, individual dual mode Full / Fault Battery indicators and 4 digitally selectable performance charge profiles.

Fully automatic multi-stage charging enhances battery performance with 5 sequential stages: Analyzing, Charging, Conditioning, Auto Maintain (Energy Saver) and a once a month storage recondition mode that's safe for short and long term storage. System Check OK and Battery Status indicators provide real time installation and battery fault status feedback.

Designed for use in harsh environments with industrial grade jacketed DC and AC power cables which include molded strain reliefs and wire splitters. Listed and certified to UL Marine 1236, new energy efficient CEC and DOE requirements. 3 Year warranty with built-in safety features including dual inline waterproof fuses, reverse polarity, over-temperature, over-current, over-voltage and ignition protection.

- ProMariner Digital Technology
- Distributed-On-Demand™ Technology
- Heavy Duty Tri-Surface Extruded Heat Sink Design
- Expanded LED Display with Completion Status Gauge
- Lightweight Design
- Auto-Maintain Energy Saver Mode
- Fully Automatic 5-Stage Digital Performance Charging
- Built-in Quality and Safety
- Easy Installation and Operation
- 3 Year Warranty



44006



44020



Molded Strain Reliefs



Tri-surface Heat Sink Design



Pre-wired with Waterproof Inline DC Fuses
Industrial grade jacketed DC cables, SJTOW outdoor rated AC power cable for maximum wiring protection. Dual inline safety fuses.

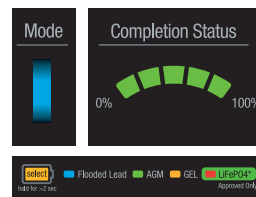

Charge Mode & Completion Guide
Red indicator for low battery and transitions to green during charging process.

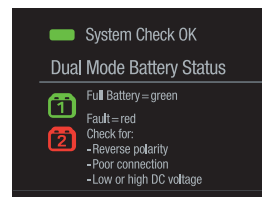

System Check OK and Dual Mode Battery Status
Red fault indication during analyze mode for user wiring or battery attention. Green indication as each battery becomes fully charged and is monitored off line.

Conforms to UL STD. 1236 SB
Certified to CSA STD. C22.2 No. 107.2
FCC Class B, CEC and DOE Listed
Designed and constructed to ABYC A-31



Approved Lithium

**See manual or promariner.com/Li for approved LiFePO4 batteries and warnings

ProSportHD Series Selection



Model	ProSportHD 6	ProSportHD 8	ProSportHD 12	ProSportHD 20	ProSportHD 20 Plus
Part #	44006	44008	44012	44020	44021
DC Voltage Systems	12V	12V/24V	12V/24V	12V/24V	12V/24V/36V
Amps	6A	8A	12A	20A	20A
No. of Batteries	1 Bank	2 Banks	2 Banks	2 Banks	3 Banks
AC & DC Cable Length	6'	6'/6'	6'/6'	6'/6'	6'/6'/6'
Size	7.9"x7.7"x2.9"	7.9"x8.9"x2.9"	7.9"x10.5"x2.9"	7.9"x12.8"x2.9"	7.9"x12.8"x2.9"
Weight	3.8 lbs	5.2 lbs	6.0 lbs	7.2 lbs	7.8 lbs
VAC / Max Amps	120V AC ±10% 50/60Hz / 2A	120V AC ±10% 50/60Hz / 2.4A	120V AC ±10% 50/60Hz / 3.6A	120V AC ±10% 50/60Hz / 6.5A	120V AC ±10% 50/60Hz / 6.5A
AC Plug	NEMA 5-15	NEMA 5-15	NEMA 5-15	NEMA 5-15	NEMA 5-15

Factory Set for Flooded/Lead-Acid Batteries

Stage 1 - Analyze & System Check OK

During this stage the ProSportHD Mode LED will pulse blue indicating it is analyzing all battery connections and ensuring each battery is capable of being charged. When completed successfully, the "System Check OK" indicator will illuminate green. This takes approximately 1 minute.

Stage 2 - Charge

During this stage the ProSportHD Mode LED will be solid red and the ProSportHD will use all of its available charging amps (as controlled by temperature) until the battery voltage is raised to the selected absorption voltage.

Stage 3 - Condition

During this stage the ProSportHD Mode LED will be solid amber. During this mode batteries will be held at the selected absorption voltage to complete charging while conditioning each battery connected for up to 3 hours as needed.

Stage 4 - Auto Maintain (Energy Saver Mode)

During this stage the Mode indicator will be solid green, indicating it is monitoring and auto maintaining your batteries as needed to maintain a full state of charge. At this time, the blue Power LED, green System OK and green Mode LEDs will remain on letting you know your batteries are ready when you are.

Stage 5 - Storage Recondition

During this stage the ProSportHD will enter into its once a month Storage Recondition mode. The green Mode LED will pulse indicating that while your batteries / boat are in storage, the ProSportHD is reconditioning all batteries for up to 3 hours once a month to extend battery life and provide maximum reserve power performance on the water.

5 Stage Performance Charging Overview

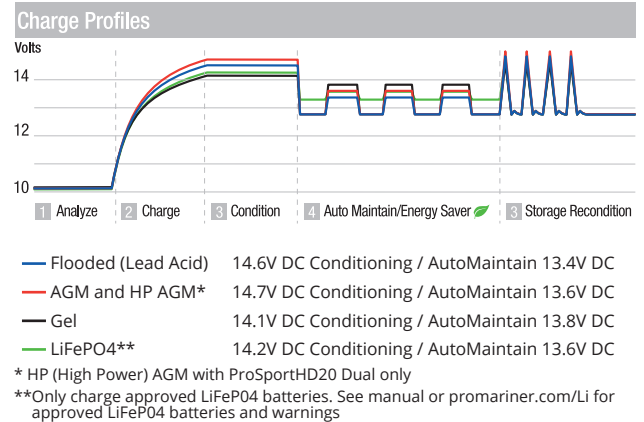

Related Products



AC Plug Holder
page 42



Cable Extender
page 43

ProSportHD Series Lithium—Global **NEW** On-Board Waterproof Battery Charger

ProSportHD series 4 boasts a new aggressive heavy duty tri-surface heatsink design. This lightweight design delivers faster charging through optimal cooling, while delivering true rated constant current charging amps during charge mode. User selectable charging profiles for Flooded, AGM, Gel and ProMariner approved LiFePO4** chemistries.

ProSportHD's enhanced microprocessor and software control sports a dashboard of new digital features including: fuel gauge style Charge Completion Monitor, Charge Mode LED bar, individual dual mode Full / Fault Battery indicators and 4 digitally selectable performance charge profiles.

Fully automatic multi-stage charging enhances battery performance with 5 sequential stages: Analyzing, Charging, Conditioning, Auto Maintain (Energy Saver) and a once a month storage recondition mode that's safe for short and long term storage. System Check OK and Battery Status indicators provide real time installation and battery fault status feedback.

Designed for use in harsh environments with industrial grade jacketed DC and AC power cables which include molded strain reliefs and wire splitters. Listed and certified to CE, RCM, CSA and UL Marine 1236, new energy efficient CEC and DOE requirements. 3 Year warranty with built-in safety features including dual inline waterproof fuses, reverse polarity, over-temperature, over-current, over-voltage and ignition protection.

- ProMariner Digital Technology
- Distributed-On-Demand™ Technology
- Heavy Duty Tri-Surface Extruded Heat Sink Design
- Expanded LED Display with Completion Status Gauge
- Lightweight Design
- Auto-Maintain Energy Saver Mode
- Fully Automatic 5-Stage Digital Performance Charging
- Built-in Quality and Safety
- Easy Installation and Operation
- 3 Year Warranty



Global AC Input
100-240 VAC 50/60 Hz



44023



44026



Molded Strain Reliefs



Tri-surface Heat Sink Design



Pre-wired with Waterproof Inline DC Fuses
Industrial grade jacketed DC cables, SJTOW outdoor rated AC power cable for maximum wiring protection. Dual inline safety fuses.

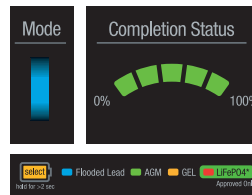

Charge Mode & Completion Guide
Red indicator for low battery and transitions to green during charging process.

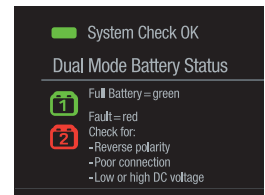

System Check OK and Dual Mode Battery Status
Red fault indication during analyze mode for user wiring or battery attention. Green indication as each battery becomes fully charged and is monitored off line.

Conforms to UL STD. 1236 SB
Certified to CE and RCM standards,
CSA STD. C22.2 No. 107.2
FCC Class B, CEC and DOE Listed
Designed and constructed to ABYC A-31



**See manual or promariner.com/Li for approved LiFePO4 batteries and warnings

ProSportHD Series—Global Selection



Model	ProSportHD 6	ProSportHD 12	ProSportHD 20	ProSportHD 20 Plus
Part #	44023	44026	44028	44029
DC Voltage Systems	12V	12V/24V	12V/24V	12V/24V/36V
Amps	6A	12A	20A	20A
No. of Batteries	1 Bank	2 Banks	2 Banks	3 Banks
AC & DC Cable Length	6'	6'/6'	6'/6'	6'/6'/6'
Size	7.9"x7.7"x2.9" 20.1 x 19.6 x 7.4cm	7.9"x11.3"x2.9" 20.1 x 28.7 x 7.4cm	7.9"x13.6"x2.9" 20.1 x 34.5 x 7.4cm	7.9"x13.6"x2.9" 20.1 x 34.5 x 7.4cm
Weight	3.8 lbs	6.4 lbs	8.2 lbs	8.8 lbs
VAC / Max Amps	100-240V AC 50/60Hz / 2A	100-240V AC 50/60Hz / 3A	100-240V AC 50/60Hz / 5A	100-240V AC 50/60Hz / 5A
AC Plug	IEC c14	IEC c14	IEC c14	IEC c14



Universal IEC c14 power cord

C13 Plug Adapters

For ProSport HD Global Universal IEC C14 power cords. Available in country C13 plug adapters as shown (not included).



Factory Set for Flooded/Lead-Acid Batteries

Stage 1 - Analyze & System Check OK

During this stage the ProSportHD Mode LED will pulse blue indicating it is analyzing all battery connections and ensuring each battery is capable of being charged. When completed successfully, the "System Check OK" indicator will illuminate green. This takes approximately 1 minute.

Stage 2 - Charge

During this stage the ProSportHD Mode LED will be solid red and the ProSportHD will use all of its available charging amps (as controlled by temperature) until the battery voltage is raised to the selected absorption voltage.

Stage 3 - Condition

During this stage the ProSportHD Mode LED will be solid amber. During this mode batteries will be held at the selected absorption voltage to complete charging while conditioning each battery connected for up to 3 hours as needed.

Stage 4 - Auto-Maintain (Energy Saver Mode)

During this stage the Mode indicator will be solid green, indicating it is monitoring and auto-maintaining your batteries as needed to maintain a full state of charge. At this time, the blue Power LED, green System OK and green Mode LEDs will remain on letting you know your batteries are ready when you are.

Stage 5 - Storage Recondition

During this stage the ProSportHD will enter into its once a month Storage Recondition mode. The green Mode LED will pulse indicating that while your batteries / boat are in storage, the ProSportHD is reconditioning all batteries for up to 3 hours once a month to extend battery life and provide maximum reserve power performance on the water.

5 Stage Performance Charging Overview

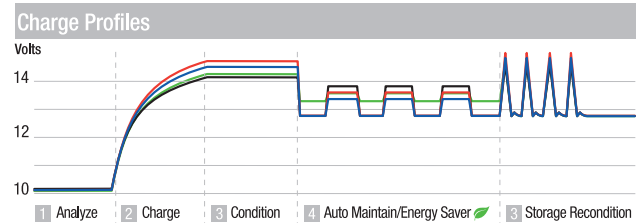

- Flooded (Lead Acid) 14.6V DC Conditioning / AutoMaintain 13.4V DC
- AGM and HP AGM* 14.7V DC Conditioning / AutoMaintain 13.6V DC
- Gel 14.1V DC Conditioning / AutoMaintain 13.8V DC
- LiFePO4** 14.2V DC Conditioning / AutoMaintain 13.6V DC

* HP (High Power) AGM with ProSportHD20 Dual only

**Only charge approved LiFePO4 batteries. See manual or promariner.com/Li for approved LiFePO4 batteries and warnings

Related Products



Cable Extender page 43

ProMar1 Digital Series Recreational Marine & Industrial Grade On-Board Battery Chargers

The ProMar1 DS takes charging performance to the next level. It sets new standards in efficiency with all-digital integrated technology. The fully Automatic 4-Stage Charging algorithm, which includes sequential modes of Analyzing, Charging, Conditioning and built-in Auto-maintain, has been proven to prolong battery life. ProMar1 DS is safe for short and long-term storage periods.

Intended for harsh environments, ProMar1 DS is built with industrial grade jacketed DC cables, SJTOW rated AC cables, and enclosed in a fully encapsulated IP68 waterproof and shock-proof housing.

Integrated LED lights provide at-a-glance indication of charge status and wiring conditions for each individual output.

ProMar1 DS is designed and certified to UL Marine 1236, the new energy efficient CEC (California Energy Commission) and DOE (Department of Energy) requirements to ensure reliability and low-emission operation.

- **Fully automatic 4-stage charging**
Analyzing, charging, conditioning and built-in auto-maintain mode
- **Single preset charging profile**
Use with Flooded (Lead-Acid) or Gel batteries
- **Integrated LEDs** for battery status and fault detection
- **Auto-maintain / energy saver modes** extends battery life
- Pre-wired with waterproof inline DC fuses and nickel-plated copper ring terminals **1**
- **Built-in safety features**
Dual inline DC safety fuses for all multi-bank models, reverse polarity, over-temperature, over-current, over-voltage and ignition protection
- **Meets US FCC emissions requirements and CEC compliance**
- 3 Year Warranty



1
Prewired with Waterproof
Inline DC Fuses and Nickel
Plated Copper Ring Terminals

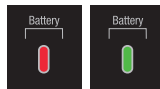

**Dual Mode Charge
LED Indicator**
Red: Charging Green:
Auto-maintain/Energy Saver

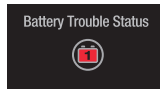

**Battery & Wiring
Fault Detection**



31505



31515

ProMar1 Digital Series Selection



Model	ProMar1 DS 5	ProMar1 DS 10	ProMar1 DS 15
Part #	31505	31510	31515
Volts DC	12V	12V/24V	12V/24V/36V
DC Amps	5A	10A	15A
Max No. of Batteries	1 Bank	2 Banks	3 Banks
Charging	up to 14.1V DC	up to 14.1V DC	up to 14.1V DC
Auto-maintain	12.8-13.5V DC	12.8-13.5V DC	12.8-13.5V DC
DC Cable Length	6'	6'/6'	6'/6'/6'
Size	6.4"x4.1"x2.4"	9.2"x5.7"x2.4"	10.5"x6.5"x3.0"
Weight	4 lbs	7 lbs	11 lbs
VAC / Max Amps	110-120V DC, 50/60Hz / 1.2A	110-120V DC, 50/60Hz / 2.4A	110-120V DC, 50/60Hz / 3.6A
AC Plug	NEMA 5-15	NEMA 5-15	NEMA 5-15
Operating Temperature	-4°F to 122°F (-20°C to 50°C)*	-4°F to 122°F (-20°C to 50°C)*	-4°F to 122°F (-20°C to 50°C)*
Storage Temperature	-40°F to 158°F (-40°C to 70°C)	-40°F to 158°F (-40°C to 70°C)	-40°F to 158°F (-40°C to 70°C)

*output derates at 122°F (50°C)

Fully Automatic 4-Stage Charging

Stage 1 - Analyze Mode

AC Power is applied. ProMar1 DS's red Charging LED will light indicating it is analyzing individual wiring connections for proper connection/polarity and that each battery is over 4.0 VDC and capable of accepting a precharge. When completed, any errors will trip a battery specific red fault LED, or if no faults are present the red Charge LED will remain solid red.

Stage 2 & 3 - Charge / Conditioning Mode

During this mode the red charging LED will be solid on indicating each battery is being charged in constant current mode as controlled by temperature until the battery voltage is raised to 14.1 VDC and will hold at 14.1 VDC in constant voltage mode for 2 to 3 hours to condition each battery. When completed, the red Charging LED will shut off.

Stage 4 - Energy Saver Auto-maintain Mode

During this mode the blue AC Power and green Auto-maintain LED will be solid on indicating each battery is being monitored while the charger is in standby mode consuming little to no power until the battery drops under 12.8 VDC (fully charged) and the charger outputs will turn on and auto-maintain the battery in a fully charged state. This is fully automatic and safe for short and long term storage.

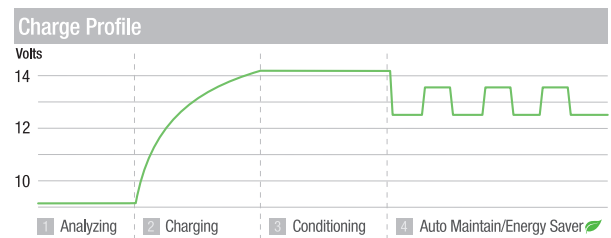

Related Products



AC Plug Holder
page 42



Cable Extender
page 43

ProSport 1.5 Amp Fully Automatic Battery Maintainer & Charger

Ideal for personal watercraft, recreational ski and wake boats, ATV's, tractors and more.

Our newest generation ProSport 1.5 Amp fully automatic maintainer is an innovative multi-use charger designed for maximum utility. Concealed mounting holes allow the ProSport 1.5 to be installed on-board or to be used as a portable, with rear die cut foam resting pad. Ring terminal and DC clamp quick connect cable assemblies included.

Our marine grade design is weatherproof, water-resistant to IP65 and can be used in all fresh and salt water outdoor and indoor applications as needed.

Designed to keep 12V batteries fully charged during short or long term storage periods, ProSport's Energy Saver mode will monitor and auto-maintain a battery when needed to maintain a full state of charge. This energy saving mode will significantly reduce AC Power consumption, lower operating costs and maximizes reserve power performance.

- Fully automatic energy saving design
- Multi-use design, easily configures for on-board or portable use
- Concealed mounting holes & die cut foam resting pad for portable use
- Expanded LED display for Power, Charging and Auto-maintain status
- Maintain 12 volt lead acid (sealed & vented) batteries up to 150 amp hours
- Quick connect DC clamp & ring terminal assemblies
- Weatherproof and water resistant to IP65 (see inside back cover)
- Built-in safety with reverse polarity, short circuit, temperature and ignition protection
- Pre-wired for easy installation
- 3 Year Warranty



44001



Concealed Mounting

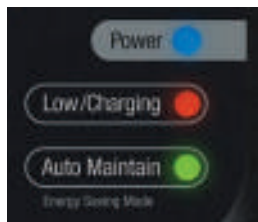

Expanded LED Status Center



Portable Foam Resting Pad



Included DC Cable Assemblies

Model	ProSport 1.5 Maintainer
Part #	44001
Battery Type	12V lead acid (sealed & vented)
Volts	12V DC
Amps	1.5
Banks	1
Auto-maintain	Monitored float range 12.9V DC to 13.4V DC
VAC / Max Amps	120V AC 50/60Hz / .4A
Cable Length	6'
AC Plug	3-wire, NMEA 5-15P
Size	5.0"x5.75"x1.97"
Weight	2.3 lbs

Related Products



AC Plug Holder
page 42



Conforms to:
Marine UL 1236 SB
CSA C22.2 No. 107.2
FCC Class A

Designed and
Constructed to:
ABYC A-31
Boating Safety... Built In

Use the ProSport 1.5 Amp Maintainer & Charger for a variety of applications:



VENTED BATTERY CHARGERS



VENTED BATTERY CHARGERS

ProNauticP Series



24

ProNauticP's Generation 3 ProMar Digital Performance Charging Platform combines digital control and software-based power conversion technology with global energy management features.



ProNauticP Series ProMar Digital Performance Charging

All Digital Electronic Charging...

Winner of the IBEX Innovation Award, ProNauticP's Generation 3 ProMar Digital Performance Charging Platform combines digital control and software-based power conversion technology with global energy management features.

ProNauticP is designed for the growing demand for more 12V electronics on-board today's power, sail, cruising and sport fishing boats. Highlighting twelve digitally-controlled performance charging profiles and a full digital display **1**. ProNauticP offers features not seen on competitive chargers including: Self Test Diagnostics, real time system voltage and amperage, discreet fault indication and once-a-month storage reconditioning modes to extend the life of your batteries.

ProNauticP is designed to provide more time away enjoying what you like most... boating, fishing and camping.

- **Distributed-On-Demand™ Technology**

Automatically senses and distributes up to full capacity to any one bank or combination of all banks.

- **ProMar Digital Charging Performance - 12 Selectable Profiles **2****

Up to 12 performance & precision 4-stage charging profiles: Charge, Condition, Auto-maintain and Recondition. Automatic dockside power mode for 12V DC lighting and appliances. Factory set for sealed batteries. Flooded (Lead Acid), AGM, GEL selectable.

- **Power Factor Correction - Global AC Input**

Auto-ranging (100-240V AC/50-60Hz) global AC input with reduced harmonic distortion. ProNauticP consumes less power so more AC power is available on-board.

- **Conservation Energy Saver Mode **3****

After fully charging and conditioning batteries, ProNauticP's Energy Saver Mode will monitor and Auto-maintain batteries only when needed, maintaining a full state of charge. This significantly reduces AC power consumption while lowering operating costs and maximizing reserve power performance.

- **Digital Self-Calculating Absorption and Battery Health Reconditioning Mode**

Automatically programs conditioning time based on discharge state of batteries. Automatically reconditions batteries after 21 days in the Auto-maintain Mode, improving reserve power performance and extending battery life.

- **Service and Fault Mode LED Indicators**

Real time indication of wiring faults or adverse conditions that may impact the operation of a boat's charging system.

- **Automatic Fan Speed Control**

Quiet operation. Innovative front exhaust prevents restriction of air flow and cooling.

- **Automatic Temperature Compensation and Built-in Safety**

Remote temperature probe included - Ignition protected and current limiting. Designed and constructed to: Marine ULc 1236, CE, CTick, FCC Class B and CEC.

- 5 Year Warranty



Global AC Input

100-240 VAC 50/60 Hz



63140

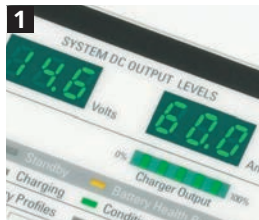

1
Dual Digital Displays and Power Output Bar



2
Battery Type and EZ View Service Indicators



3
Auto Conservation and Self Test Modes

Safety Certified by:



To Standards:
UL 1236 SB
CSA C22.2-107.2



ProNauticP Series Selection



Model	ProNautic 1210P	ProNautic 1215P	ProNautic 1220P	ProNautic 1230P	ProNautic 1240P	ProNautic 1250P	ProNautic 1260P	ProNautic 2420P	ProNautic 2430P
Part #	63110	63115	63120	63130	63140	63150	63160	63170	63180
Volts	12V	12V	12V	12V	12V	12V	12V	24V	24V
Amps	10A	15A	20A	30A	40A	50A	60A	20A	30A
Banks	2 Bank	3 Bank	3 Bank	3 Bank	3 Bank	3 Bank	3 Bank	3 Bank	3 Bank
AC Input Voltage	100-240 Autoranging	100-240 Autoranging	100-240 Autoranging	100-240 Autoranging	100-240 Autoranging	100-240 Autoranging	100-240 Autoranging	100-240 Autoranging	100-240 Autoranging
AC Amperage at 100/240V AC	< 3.0 / < 1.5	< 4.0 / < 2.0	< 5.0 / < 2.5	< 6.0 / < 3.0	< 7.0 / < 3.5	< 10.0 / < 5.0	< 11.0 / < 5.5	< 7.0 / < 3.5	< 11.0 / < 5.5
Cycle	50/60	50/60	50/60	50/60	50/60	50/60	50/60	50/60	50/60
Size (LxWxH)	10.25"x8.5" x3.5" 26 x 21.6 x 8.9 cm	10.25"x8.5" x3.5" 26 x 21.6 x 8.9 cm	10.25"x8.5" x3.5" 26 x 21.6 x 8.9 cm	10.25"x8.5" x3.5" 26 x 21.6 x 8.9 cm	10.25"x8.5" x3.5" 26 x 21.6 x 8.9 cm	12.25"x8.5" x3.5" 31.1 x 21.6 x 8.9 cm	12.25"x8.5" x3.5" 31.1 x 21.6 x 8.9 cm	10.25"x8.5" x3.5" 26 x 21.6 x 8.9 cm	12.25"x8.5" x3.5" 31.1 x 21.6 x 8.9 cm
Weight	5 lbs	5 lbs	5 lbs	6 lbs	6 lbs	7 lbs	8 lbs	6 lbs	8 lbs

Digitally Controlled Charge Profiles

	12V Models				24V Models			
	Preset 1		Preset 2		Preset 1		Preset 2	
Battery Type	Conditioning V DC	Auto-maintain V DC Range	Conditioning V DC	Auto-maintain V DC Range	Conditioning V DC	Auto-maintain V DC Range	Conditioning V DC	Auto-maintain V DC Range
Flooded	14.8V DC	12.8-13.6V DC	14.7V DC	12.8-13.4V DC	29.6V DC	25.6-27.2V DC	29.4V DC	25.6-26.8V DC
Sealed	14.4V DC	12.8-13.6V DC	14.6V DC*	12.8-13.4V DC*	28.8V DC	25.6-27.2V DC	29.2V DC*	25.6-26.8V DC*
AGM	14.4V DC	13.0-13.4V DC	14.6V DC	13.0-13.6V DC	28.8V DC	26.0-26.8V DC	29.2V DC	26.0-27.2V DC
GEL	14.0V DC	13.2-13.7V DC	14.4V DC	13.2-13.8V DC	28.0V DC	26.4-27.4V DC	28.8V DC	26.4-27.6V DC
LiFePO4 - Lithium	13.8V DC	13.2-13.8V DC	14.6V DC	13.2-14.6V DC	27.6V DC	26.4-27.6V DC	29.2V DC	26.4-29.2V DC
Calcium/Prgm Custom	15.1V DC	13.2-13.6V DC	PrgmV DC**	PrgmV DC**	30.2V DC	26.4-27.2V DC	PrgmV DC***	PrgmV DC***
Equalization	15.5V DC	15.5V DC	15.5V DC	15.5V DC	31.0V DC	31.0V DC	31.0V DC	31.0V DC

* Factory setting **Default : Conditioning = 13.6V DC, Auto-maintain = 13.2-13.6V DC ***Default: Conditioning = 27.2V DC, Auto-maintain = 26.4-27.2V DC



Remote Temperature Sensor Probe (included)

The ProNauticP comes standard with a temperature probe that is plug and play. Once the temperature sensor is connected, the charger will adjust its charge based on the batteries temperature.

Part # 63106



Digital Display and Control Remote (optional)

ProNauticP optional remote available for interactive remote port for digital display and control.

Part # 63100

Related Products



ProIsoCharge Series page 36

COMMERCIAL/ INDUSTRIAL CHARGERS



COMMERCIAL/INDUSTRIAL CHARGERS

ProTechOne Digital Series Battery Chargers

28

Utilizes the latest in microprocessor and software control charging and energy saving auto-maintain technology. Safe for short and long term storage with multi-stage charging, conditioning and auto-maintaining proven to maximize battery performance and life.



ProTechOne Digital Series Fully Automatic On-board Battery Charger & Maintainer



ProMariner's ProTechOne Fully Automatic On-Board Battery Charger and Maintainer utilizes the latest in microprocessor and software control charging and energy saving auto-maintain technology. Safe for short and long term storage with multi-stage charging, conditioning and auto-maintaining proven to maximize battery performance and life. Designed for weatherproof applications and years of trouble free use, ProTechOne boasts a gasketed molded case design for outdoor use with commercial grade jacketed AC and DC cables for maximum cable protection and durability.

ProTechOne incorporates a push-to-test battery status monitor showing remaining battery power, in addition to fault detection of battery connections, reverse polarity or battery too low to charge. In the event of a fault, both the Charging and Auto-maintain LEDs will remain off.

An angled easy-to-view LED dashboard provides quick status of AC Power, Charge Mode and Auto-maintain (Energy Saver) mode, which controls the charging output as needed to maintain a fully charged battery, lowering AC consumption and reducing operating cost.

- All Digital Charging Technology
- Weatherproof Gasketed Rugged Plastic Molded Housing
- Fully Automatic Multi-stage Digital Charging
- Dedicated Battery Charging, Sensing and Control
- Push-to-test Battery Monitor LED Fuel Gauge Status
- Auto-maintain Energy Saver Mode
- Pre-wired Easy Installation
- For All 12V Flooded (Lead Acid) & Gel Batteries
- Built-in Safety—Reverse Polarity, Ignition, Over-Current, Over-Voltage and Over-Temperature protection
- Waterproof DC Safety Fuse For Maximum DC Wire Protection
- Listed to UL 1236, CSA C22.2 No. 107.2, CEC & DOE
- Ignition Protected And FCC Class A for Quiet Operation and Non Radio Interference
- 2 Year Warranty

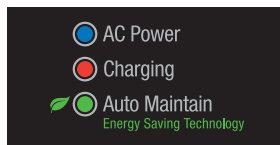

LED Charge Mode Indicator



Waterproof DC Safety Fuse For Maximum DC Wire Protection

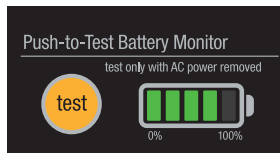

Push-to-test Battery Monitor LED Fuel Gauge Status



Integrated AC Power Inlet with Cover and Quick Mounting Indexing. (Model Specific).



Conforms to UL STD 1236
Certified to CSA STD. C22.2 No. 107.2
FCC Class A, CEC & DOE Listed

ProTechOne Series Selection



	Integrated AC Power Inlet with Self-Closing Cover		AC Corded Model with 2.5' Power Cord	
Model	ProTechOne 4	ProTechOne 5	ProTechOne 4	ProTechOne 5
Part #	24104	24105	25104	25105
Amps	4A	5A	4A	5A
DC Voltage Systems	12V	12V	12V	12V
No. of Batteries	1 Bank	1 Bank	1 Bank	1 Bank
AC & DC Cable Length	2.5'	2.5'	2.5'	2.5'
Size	4" x 6.1" x 2.6"	4" x 6.1" x 2.6"	4" x 6.1" x 2.6"	4" x 6.1" x 2.6"
Weight	1.2 lbs	1.2 lbs	1.4 lbs	1.4 lbs
VAC / Max Amps	110-120V AC, 50/60Hz / 1A	110-120V AC, 50/60Hz / 1.2A	110-120V AC, 50/60Hz / 1A	110-120V AC, 50/60Hz / 1.2A

Specifications subject to change without notice

ProTechOne's 3-Stage Digital Charging algorithm is fully automatic and designed to extend battery life.

Stage 1 & 2 - Charge / Conditioning Mode

During this mode the red charge LED will be solid on indicating the battery is being charged in constant current mode as controlled by temperature until the battery voltage is raised to 14.1 VDC and will hold at 14.1 VDC in constant voltage mode for 2 to 3 hours to condition the battery. When completed, the red Charging LED will shut off.

Stage 3 - Energy Saver Auto-maintain Mode

During this mode the green Auto-maintain LED will be solid on indicating the battery is being monitored while the charger is in standby mode consuming little to no power until the battery drops under 12.8 VDC (fully charged) and the charger outputs will turn on and auto-maintain the battery in a fully charged state. This is fully automatic and safe for short and long term storage.

3 Stage Performance Charging Overview

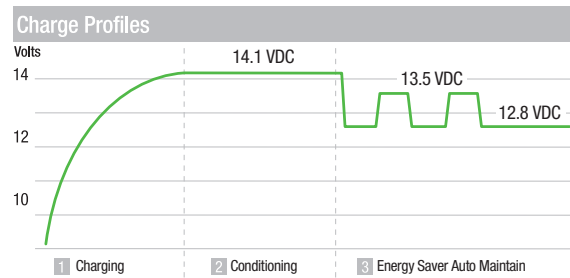

Related Products



AC Plug Holder
page 42



Cable Extender
page 43

INVERTERS



INVERTERS

TruePower Plus Series



32

Our next generation of TruePower Plus Inverters are available in both Modified Sine Wave (MS) and Pure Sine Wave (PS) models. Designed to convert 12V DC battery power to 115V AC and will automatically pass through AC Inlet power when present.

ProSport Power Inverter



33

Perfect for the on-board or on-the-road active user who needs to convert 12V battery power to 110V AC. While on the water or in your car, provide instant AC power for laptops, cell phone chargers, radios, portable TV's, lighting, small power tools and more.



TruePower Plus Series

Heavy Duty Marine, Mobile and Industrial Grade Inverters

Our next generation of TruePower Plus Inverters are available in both Modified Sine Wave (MS) and Pure Sine Wave (PS) models. Designed to convert 12V DC battery power to 115V AC and will automatically pass through AC Inlet power when present. TruePower Plus is rich with features including; Innovative dual color digital LCD message center, dual color gauges for AC power output and battery DC input, USB power port, GFCI convenience outlets, DC cable covers, and separate on/off remote. Our integrated AC cable strain reliefs and front screw connection terminal blocks allow for quick and easy installation without the added need for ring terminals for AC power connections.

Designed with soft start noise filtered technology and 2x surge capability for powering demanding loads. Shock resistant construction with internal conformal coated electronics for protection in harsh environments.

The TruePower Plus PS Series has all the features of our MS series but provides a Pure Sine 115V AC output ideal for high fidelity audio visual systems in addition to appliances with hysteresis and variable motor speed controls like washing machines and refrigeration etc.

- Intuitive dual color digital LCD message center
- Dual color gauges for AC power output and battery DC input
- Internal 30AAC transfer switch will automatically pass through AC inlet power when present
- USB power port and GFCI convenience outlets
- Compact and lightweight design
- Soft start noise filtered technology with 2x surge capability
- On/Off remote with 9 foot cable and DC cable covers included
- Integrated AC power cable strain reliefs for ease of installation
- Built-in safety with overload, over temperature, short circuit and reverse polarity protection
- Audible alarm and shut down for low and high DC voltage, overload and over temperature conditions
- Shock resistant construction with internal conformal coated electronics
- 2 Year Warranty



07100



06150



LEARN MORE
TruePower Plus
Inverters Video



Visit ProMariner
on YouTube.com



Intuitive Dual Color Display and LCD Message Center



USB 5V DC/2.1 Amp Port GFCI Protected Outlets



Integrated AC Power Strain Reliefs with Front Screws



DC Cable Covers Black (-) and Red (+)



TruePower Plus Display Functions

DC to AC Output Gauge—Indicates percentage of AC power being used versus output rating. The scale turns red when output demand exceeds output rating.

Input Power—Indicates if power is coming from DC (batteries) or AC inlet power.

DC Input Level Gauge—Indicates the battery DC voltage level. The scale turns red when battery voltage drops below 11V.

System Status—Dual color LCD with full system normal and fault condition messaging (no codes).

Check—Illuminates when a fault condition is present with LCD message.



Conforms to:
UL STD. 485
CSA STD. C22.2 No. 107.2
FCC Class B

Designed and
Constructed to:
ABYC A-31



TruePower Plus Series Selection



Model	TruePower Plus 1000ps	TruePower Plus 2000ps	TruePower Plus 1200ms	TruePower Plus 1500ms	TruePower Plus 2000ms
Part #	07100	07200	06120	06150	06200
Wattage	1000 W	2000 W	1200 W	1500 W	2000 W
Surge Rating	2000 W	4000 W	2400 W	3000 W	4000 W
Sine Wave	Pure	Pure	Modified	Modified	Modified
Efficiency (optimum)	>90%	>90%	>90%	>90%	>90%
AC Output	115V AC / 60Hz	115V AC / 60Hz	115V AC / 60Hz	115V AC / 60Hz	115V AC / 60Hz
Internal AC Transfer Switch	30A	30A	30A	30A	30A
AC Crossover Time	<30 ms	<30 ms	<30 ms	<30 ms	<30 ms
DC Input	11-15V DC	11-15V DC	11-15V DC	11-15V DC	11-15V DC
Inverter Off DC Amp Draw	4 mA	4 mA	4 mA	4 mA	4 mA
Size	4" x 9.9" x 12.4"	4.5" x 10.6" x 15.4"	4" x 9.9" x 11.5"	4" x 9.9" x 12.4"	4.5" x 10.6" x 14.6"
Weight	8.5 lbs	12 lbs	7.5 lbs	7.5 lbs	12 lbs



TruePower Plus Remote (included)

- On/Off control
- Input power source LED indicators
- Check fault LED indicator
- Remote mounting screws and 9 ft. cable included

Replacement Part # 07211

TruePower Plus 1000PS OE

Designed exclusively for OEM.

- Pre-wired with 6' AC input NEMA 5-15P power cord and 6' AC output cable terminated with three push-in style wire connectors
- No GFCI



Part #	07101
Wattage	1000 watts
Surge Rating	2000 watts
Sine Wave	Pure
Efficiency (optimum)	>90%
AC Output	115V AC / 60Hz
Internal AC Transfer Switch	15A
AC Crossover Time	<30 ms
DC Input	11-15V DC
Inverter Off DC Amp Draw	4 mA
Size	4" x 9.9" x 11.5"
Weight	7.3 lbs



Pre-wired AC cables with over-molded strain relief



Push-in style connectors for 12 to 14 AWG stranded or solid copper wire

ProSport Power Inverter Converts 12V DC power to 110V AC up to 150 W

Perfect for the on-board or on-the-road user to convert 12V DC battery power to 110V AC.

- Recharge and power portable electronics—Power devices from your car, RV, camper and more
- On the road power—Use with laptops, game consoles, portable DVD players, TVs and more
- Extruded aluminum case
- Universal cup holder design
- High surge capacity
- Power / status LED indicators
- Standard 110V AC receptacle
- Output short & input polarity protection
- Low Battery Shutdown
- Over temperature and overload protection



Part #	Surge Capability	Input	AC Output	Size (LxWxH)	Cable Length
79018	250 W	12V DC	110V AC / 60 Hz	2.625"x 2.625"x6"	3 ft

ISOLATORS AND COMBINERS

ProIsoCharge Series



36

ProIsoCharge delivers digitally controlled alternator output distribution while protecting the health of engine start batteries, isolating and charging up to 3 other independent battery banks off of a single alternator (model specific).

Multi Battery Isolator



37

ProMariner Battery Isolators with gold-plated terminals (select models) and improved efficiency, provide enhanced charging.



ISOLATORS AND COMBINERS

ProSafeFS Series



38

The ProSafe FS Series of FailSafe 30 and 60 amp Galvanic Isolators will interrupt galvanic current flow with other boats at a marina when installed on a boat which is connected to AC Shore Power.

Multi Battery Combiner



39

Merge multiple power sources with the ProMariner Multi Battery Combiner and ensure mission-critical marine equipment and electronic engine control systems benefit from dependable, uninterrupted power.



ProlsoCharge Series Intelligent Alternator Power Distribution System

Significantly Smarter...

ProlsoCharge delivers digitally controlled alternator output distribution while protecting the health of engine start batteries, isolating and charging up to 3 other independent battery banks off of a single alternator (model specific). For dual engine applications, ProlsoCharge offers an exclusive 2 alternator input model with up to 4 battery banks. Save space and time by eliminating traditional diode based isolators and ancillary voltage sensitive relays or solenoids, isolating and charging multiple battery banks simultaneously. Eliminate typical alternator voltage loss of up to .6V DC that is commonly associated with traditional diode based isolators. Intelligent zero volt loss isolation insures fully charged batteries and faster charge times. Installed with the ProNauticP Series, a boat owner can enjoy the full benefit of shore power and on the water charging. Designed to provide more time on the water enjoying what you like most...boating.

- ProMar Digital Performance Zero Volt Loss Isolation and Charging**
 All digital design delivers active battery status and automatic engine battery health priority while digitally distributing the full output of your engine's alternators.
- Intelligent Isolation and Charging Software Control**
 ProlsoCharge's intelligent software control provides priority charging to a battery bank that is under load (i.e house bank or power inverter bank) by taking fully charged batteries off line and priority charging discharged battery banks, while insuring the health of the engine batteries.
- Real Time LED Status Indicators**
 Highly visible LEDs to indicate alternator power is present and battery bank charging status. Fault LEDs include: high and low alternator output, over-voltage protection and high voltage conditions that may be present on any one of the battery banks connected (that are also connected to other charging sources gen set combi etc).
- Ignition Controlled**
 Distributed On Demand™ battery bank management will only activate with ignition power on.
- Advance Regulator Ready**
 Advance regulator remote sense connection provided for precision alternator algorithm control for alternators equipped with an advanced regulator.
- Easy Installation**
 Modular design for easy install. Includes all terminal stud insulator boots and protective snap on safety cover.
- Built-in Safety**
 Ignition protected
- 5 Year Warranty



23127



23121

Model	ProlsoCharge120 1•2	ProlsoCharge180 1•2	ProlsoCharge120 1•3	ProlsoCharge250 1•2	ProlsoCharge180 1•3	ProlsoCharge250 1•3	ProlsoCharge130 2•4
Part #	23121	23122	23124	23123	23125	23126	23127
Volts	12V	12V	12V	12V	12V	12V	12V
Max DC Amps	120A	180A	120A	250A	180A	250A	130A
Alternator Input	1	1	1	1	1	1	2
Battery Outputs	2	2	3	2	3	3	4
Size (LxWx3.125")	5.35"x5.875"	6.15"x5.875"	6.15"x5.875"	6.95"x5.875"	7.55"x5.875"	8.875"x5.875"	12.05"x5.875"
Weight	2 lbs	3 lbs	3 lbs	4 lbs	5 lbs	6 lbs	7 lbs

ProSafeFS Series Galvanic Isolator

Protecting your Boat's Outdrive, Props and Metal Fittings while Maximizing Zinc Life...

The ProSafeFS Series of FailSafe 30A and 60A Galvanic Isolators will interrupt galvanic current flow with other boats at a marina when installed on a boat which is connected to AC shore power. This technology maintains AC safety ground and solves the most common forms of corrosion and premature zinc loss within a boats bonding system. The ProSafeFS Series is UL certified to meet the parameters of the ABYC A-28 recommendation. ProSafeFS installs easily and does not require a dedicated monitor to verify the operational status of the galvanic isolator as required by non FailSafe certified galvanic isolators. Both the ProSafe 30A and 60A models are built on robust flat pack semiconductor platforms, ensuring that in the event of a failure, the failure is safe by not compromising the ground continuity on-board when connected to AC shore power.

- **ABYC A-28 Compliant and Fail Safe Certified**

Certified by Underwriters Laboratories (UL). Ensures shore power safety ground wire is maintained through the isolator.

- **Flat Pack High Power Semiconductors**

Robust high power diodes allow the FS Series to meet the FailSafe criteria for conducting inrush currents 3,000A and 5,000A (FS30 and FS60 respectively) for the required duration period.

- **Innovative Design**

The FS60 will cool itself in the event it must conduct current insuring cooler operation in this mode.

- **Ignition Protected**

Meets ISO 8846 and either model can be mounted within an engine compartment.

- **Gold Plated Terminations**

Simply install in your on-board green safety ground wire (between your AC inlet and your AC panel) to separate your DC bonding system from your shore AC green wire.

- ProSafeFS30 for 30A shore cord applications. ProSafeFS60 for (1) 50A or (2) 30A shore cord applications.
- 5 Year Warranty



22034



22074



Model	ProSafeFS30	ProSafeFS60
Part #	22034	22074
Shore Cord Inlet Compatibility	Single 15, 16, 20 or 30	Single 50 or Dual 15's, 16's, 20's or 30's
Ratings	120/240V AC / 41A / 50 or 60 Hz	120/240V AC / 82A / 50 or 60 Hz
Max Temp.	122°F (50°C)	122°F (50°C)
Size	6.75"x7"x2.5"	7.25"x6.5"x3.75"
Weight	3 lbs	3.7 lbs



Unprotected outdrives



Unprotected and premature transom & outdrive zinc loss



Unprotected sail drive

Use Galvanic Isolation to prevent corrosion.

Multi Battery Combiner

Available in a dual 80-amp and a triple 130-amp model, the ProMariner Multi Battery Combiner enables you to merge multiple sources to ensure mission-critical marine equipment and electronic engine control systems benefit from dependable, uninterrupted power. The ProMariner Battery Combiner benefits from a high-current design and high-temperature durability, resulting in a robust and reliable solution.

- High-current design
- High-temperature durability
- Waterproof IP68 rating
- Easy to install
- Small product footprint
- 50V voltage rating
- ROHS, Prop 65, CE, and ABYC E-11 compliant



2-80-1



3-130-1



Model	80 AMP	130 AMP
Part #	2-80-1	3-130-1
Battery Inputs	2	3
DC Load Output	1	1
System Voltage	50	50
Max DC Amperage	80	130
Continuous Current Rating	80A	130A
Intermittent Current Rating (30 Seconds)	100A	160A
IP Rating	IP68	IP68
Wire Gauge Minimum	6Ga 105C SGT	2Ga 105C SGT
Weight	1.35 lbs	2.35 lbs
Dimensions	100 x 115 x 79.1mm	177.1 x 115 x 79.1mm

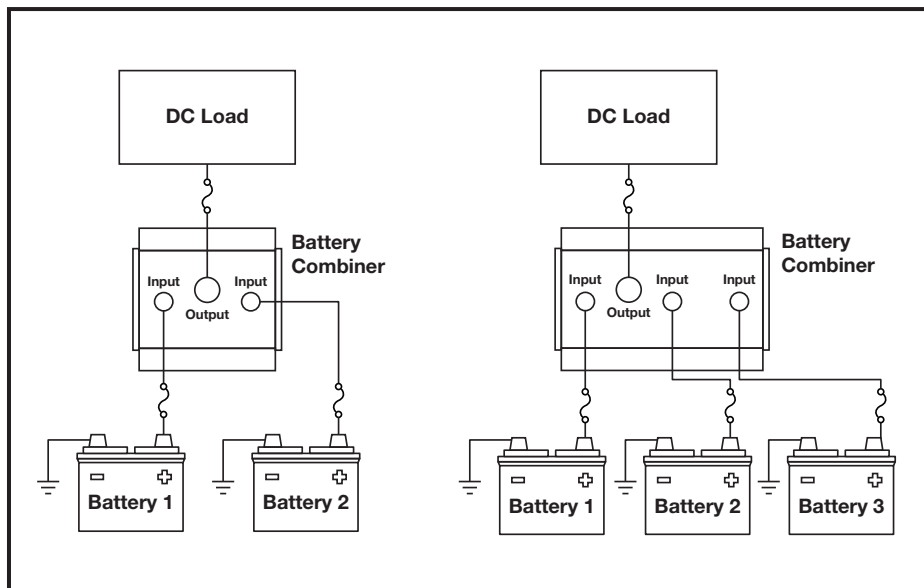

ACCESSORIES

Universal AC Plug Holder+



42

No cutting, stripping, or splicing wires. Mount in an easy-to-reach location for safe AC power cord connection.

Charger DC Cable Extenders



43

Universal design for all marine chargers with ring terminal cables. No cutting, stripping or splicing required.



ACCESSORIES

Remote Battery Bank Status Indicator



44

Remote Push-To-Test status indicator for up to 3 batteries. Universal flush or surface mount capable.

Hand Held Digital Multimeter



44

Accurate and durable Hand-Held Digital Multi-Meter with a large digital LCD display to easily see the readout.



Universal AC Plug Holder+

Universal design for all standard 120V AC plugs

- Plug clamp insert included
- Converts plug holder to an AC inlet for ProMariner engineered chargers
- No cutting, stripping or rewiring of AC power cord
- Watertight and UV resistant cover
- Easy to reach safe AC power cord connections
- Stainless steel mounting screws included
- Easy installation

Part # 51300 Black
 Part # 51310 White
 OEM # 51301 Black
 OEM # 51311 White



Plug Clamp Insert

Available in black or white

AC Plug Holder Configurations—Multi-Use Design

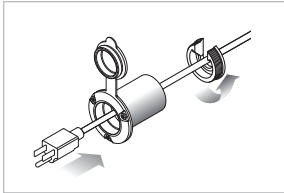

Universal Plug Holder
 Fits marine chargers with 120V plugs.

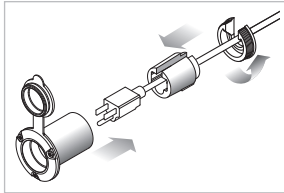

With Plug Clamp Insert
 For all ProMariner chargers, Bass Pro shops, Cabela's and Guest chargers.

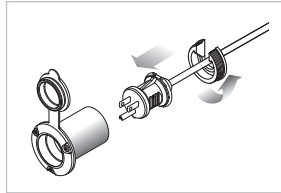

ConnectCharge™ Plug
 Guest and Marincó ConnectCharge plug



51310/51311



Charger DC Cable Extenders

Universal design for all marine chargers with ring terminal cables

- Rated up to 30A
- Color coded for quick and easy installation
- Waterproof dual in-line fuses
- No cutting, stripping or splicing required
- Slide & snap fully insulated connection covers
- Corrosion resistant tinned 12 AWG copper wire and gold plated hardware
- Dual inline waterproof fuses for maximum wire protection
- Available in 5 ft or 15 ft cable lengths
- Use with all on-board marine battery chargers when standard battery charger cables do not reach your bow, center mount or stern battery compartment locations

Part # 51815 15 ft

Part # 51805 5 ft



Easy to extend charger cables with two 1/2" wrenches



Step 1:
Align charger red and black wires and assemble hardware as shown

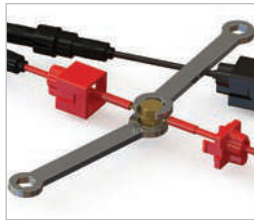

Step 2:
Tighten all hardware to approximately 12 ft. lbs.

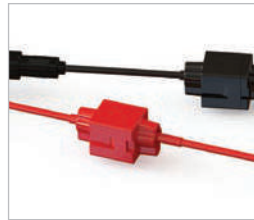

Step 3:
Slide and snap connection cover



Remote Battery Bank Status Indicator

- Remote "Push to Test" status indicators for up to 3 batteries with easy-to-read LED indicators
- Display is universal flush or surface mount capable

Part # 51060



51060

Hand-Held DC System Tester

- At-a-glance testing of batteries, on-board charger, alternator/ regulator output
- 6 Easy-to-read LED indicators
- Compact, lightweight design

Part # 87710



87710

Hand Held Digital Multimeter

- Large digital LCD display
- Back light feature
- Test leads included
- Measurement hold feature
- Built in EZ stand
- Continuity tone alert

Part # 87730



87730

What is Series Connection and Parallel Connection for batteries?

Series Connection

A series connection is used to increase voltage, while keeping capacity at the same level. Two serially connected 12V/120 Ah batteries make a combined battery set of 24V/120 Ah. In a series connection, the positive pole of one battery is connected to the negative pole of the other, with the poles that remain at the ends being connected to the system. Batteries with different capacities and chemistry should never be linked in series.

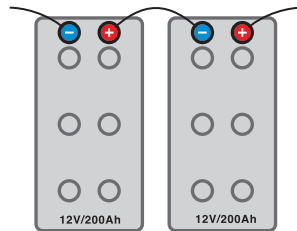

Series connection 24V/200 Ah.

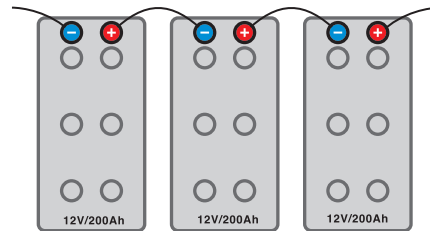

Series connection 36V/200 Ah.

Parallel Connection

Parallel connection is used when you need to increase your capacity, but keep the voltage the same. The positive leads are connected together, as are the negative leads.

The cabling from the battery to the system should be: Positive from battery 1 and negative from battery 2 (or the last in the parallel connection).

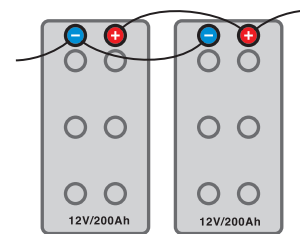

Parallel connection
12V/400 Ah.

Series/parallel Connection

If you need a 24V battery set with a higher capacity, you can combine series and parallel connections. The cables from the battery to the system must be crossed: Positive from battery 1 and negative from battery 2 (or the last in the parallel connection).

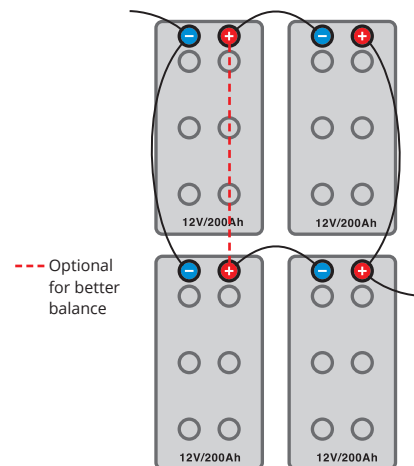

Series/parallel connection
24V/400 Ah.

TECH TIP

Space when Installing Multiple Batteries

Make sure there is sufficient space between the batteries when installing multiple batteries: There should be a 'finger' of space between them to allow the heat to be diverted below.

Part #	Page	Part #	Page
2-80-1	39	51805	43
3-130-1	39	51815	43
06120	33	53242	11
06150	33	53243	11
06200	33	53244	11
07100	33	53363	11
07101	33	53364	11
07200	33	53505	11
07211	33	55363	13
11072	37	55364	13
11073	37	55505	13
11132	37	63100	25
11133	37	63106	25
12072	37	63110	25
12073	37	63115	25
12132	37	63120	25
12133	37	63130	25
22034	38	63140	25
22074	38	63150	25
23121	36	63160	25
23122	36	63170	25
23123	36	63180	25
23124	36	79018	33
23125	36	87710	44
23126	36	87730	44
23127	36	63150	25, 48
24104	29	63160	25, 48
24105	29	63170	25, 48
25104	29	63180	25, 48
25105	29	79018	35
31505	19	87710	46
31510	19	87730	46
31515	19		
44001	20		
44006	15		
44008	15		
44012	15		
44020	15		
44021	15		
44023	17		
44026	17		
44028	17		
44029	17		
51060	44		
51300	42		
51301	42		
51310	42		
51311	42		



ProMariner®

N85W12545 Westbrook Crossing
Menomonee Falls, WI 53051 USA
p +1.603.433.4440
f +1.603.433.4442

New Zealand

42 Apollo Drive
Rosedale, Auckland 0632
New Zealand
p +64.9.415.7261
f +64.9.415.9327

The Netherlands

Snijdersbergweg 93
1105 AN Amsterdam
The Netherlands
p +31(0)20 34 22 100
f +31(0)20 69 71 006

promariner.com
support@pmariner.com

© 2025 Navico Group. All Rights Reserved.
Navico Group is a division of Brunswick Corporation

®Reg. U.S. Pat. & Tm. Off, and ™ common law marks. Visit www.navico.com/intellectual-property
to review the global trademark rights and accreditations for Navico Group and other entities.

Unauthorized copying or reproduction is a violation of applicable laws.

PRM-CAT-010-0325

FSC Details
(added by printers)